

FOLDING ARM AWNING SYSTEM

# PIUMA

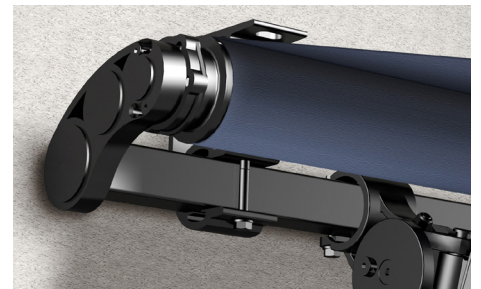
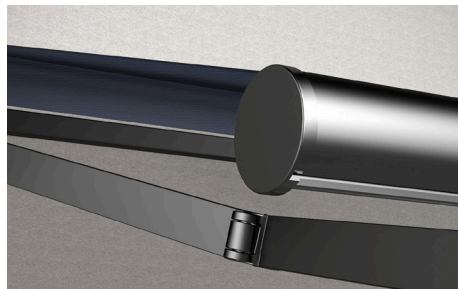

## FEATURES

- Class 2 wind resistance according to European standard EN 13561
- Certified Italian Stainless steel screws and pins
- Wall and ceiling installation
- Continuous micrometric regulation of inclination
- Inclination between 0° and 90°
- FUSION arms with DATSystem
- Maximum size of a single section: 700x315 cm
- Manually operated or motorised
- Available with protective hood

## COLOUR RANGE

Graphite White



## FABRIC PROTECTION HOOD

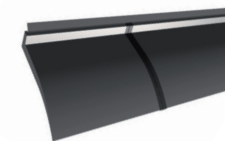

AUSTRALIA | EUROPE | USA [rolleaseacmeda.com](http://rolleaseacmeda.com)

© Rollease Acmeda Pty Ltd



**ROLLEASE  
ACMEDA**  
PRECISION IN MOTION

# CABLE ARM SYSTEM

PIUMA features the Fusion Arm with a tensioned, spring loaded, double stainless steel cable, PVC coated for added protection against corrosion.

The Dynamic Arm Torsion system is specifically designed to prevent fabric damage and sagging by maintaining constant tension.

## FEATURES

- Outstanding mechanical performance.
- Fabric damage prevention.
- Maximum durability.
- Arms can be adjusted to tilt in single degree increments.

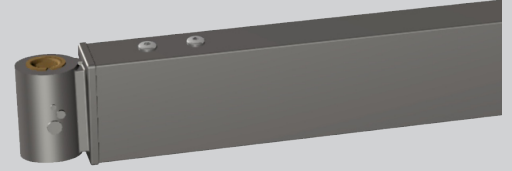

## DIMENSIONS

WALL / TOP FIX  
0° inclination

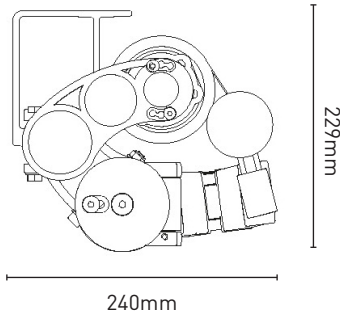

90° inclination

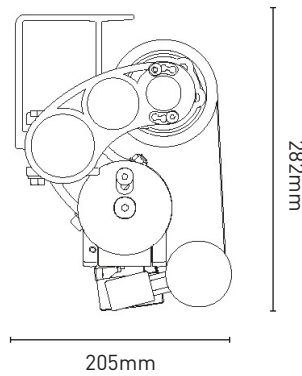

## ARM PROJECTION

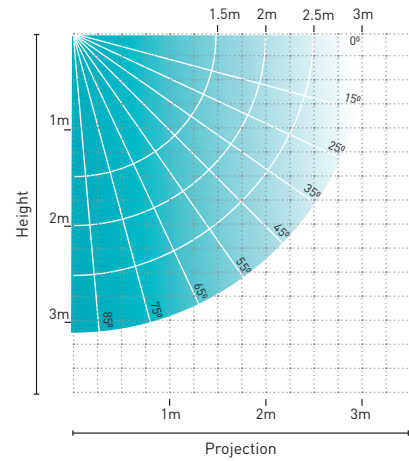

## SYSTEM CAPACITY

Max width: 7m  
Max projection: 3.15m  
Wind Resistance: Class 2,  
EN 13561 (600 cm x 265 cm)

Independently tested and approved by



## AUTOMATE MOTORISATION



Easily control your motorised awning with a remote control or smart phone device using the Automate App & Pulse 2 hub. Control awnings from anywhere in the world, set scenes and timers for automatic control and always know what your awnings are doing thanks to ARC bi-directional live feedback. The Pulse 2 also integrates with smart voice-assistants such as Google Assistant, Amazon Alexa and now Apple HomeKit with Siri.

